

Außensicht (M1:50)

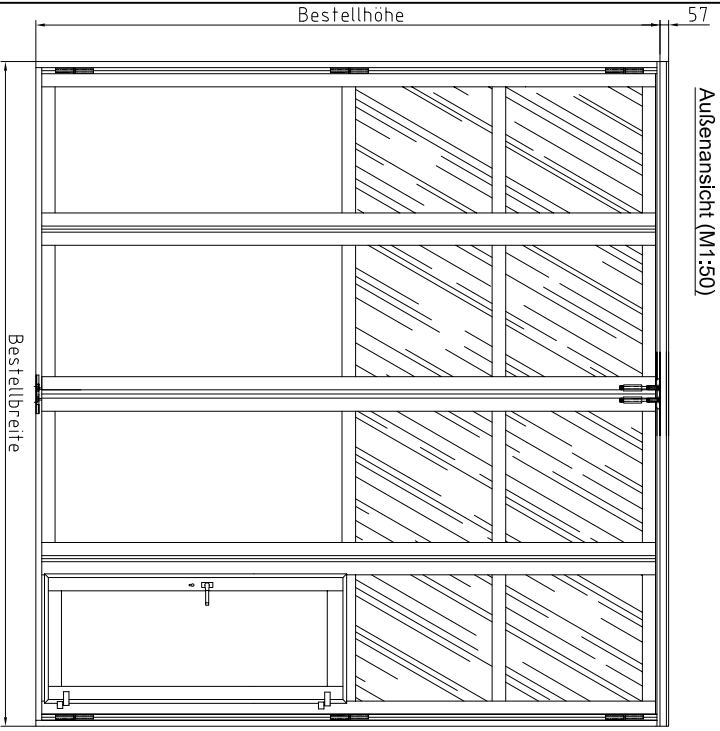

Vertikalschnitt (M1:50)



Horizontalschnitt (M1:50)

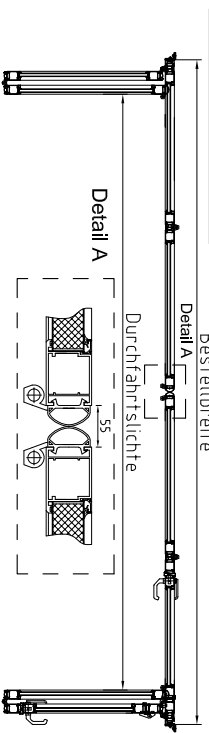

Montagesituationen (M1:10)

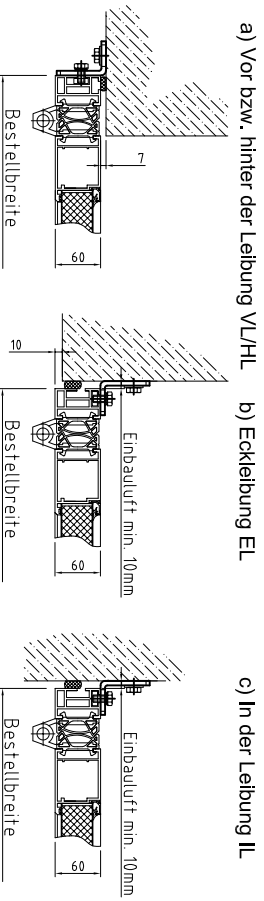

a) Vor bzw. hinter der Leibung VL/HL

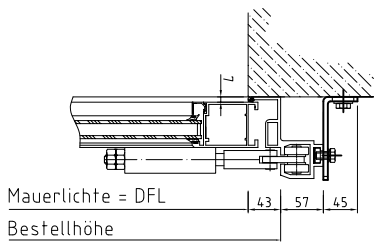

Montagesituationen im Sturz (M1:10)

b) Eckleibung EL

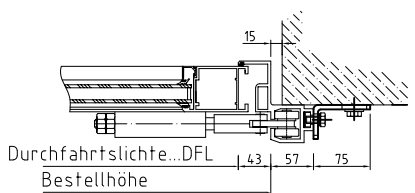

c) In der Leibung IL

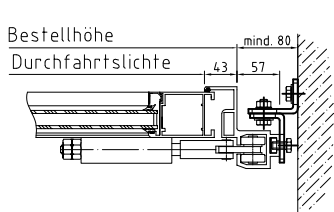

Bodendetails (M1:10)

a) Schwelle L50

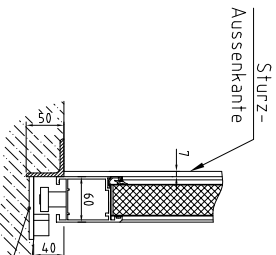

b) Schwelle L50D

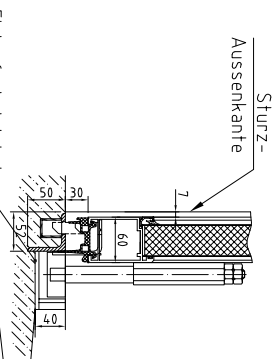

c) Schwelle U50D

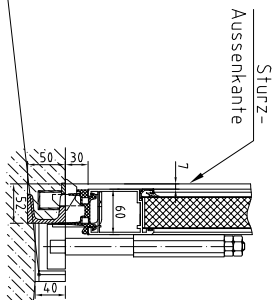

d) Schwellenlos Riegelschlag RA

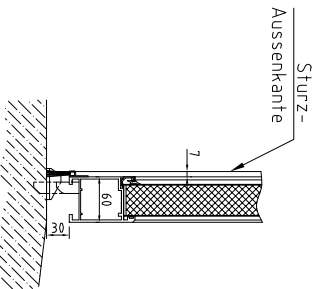

e) Flachstahlschwelle S10D

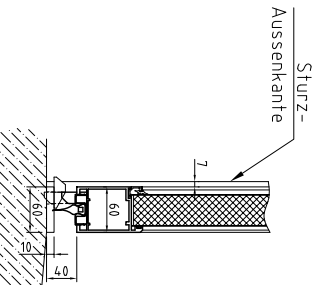

f) Bodenführung BF-light NIRO

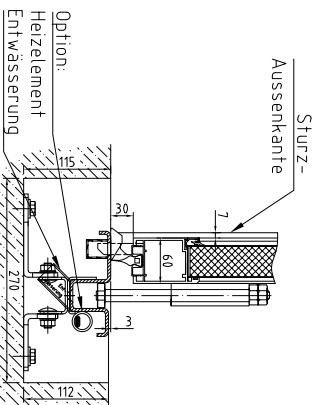

Architektenblatt
AL601F2.0

SCHNEIDER - Torsysteme GmbH,

A-4611 Buchkirchen, Kalzstraße 1

Datenframe: SCH_ARCHITECTENBLATT AL601F 2.0_2019_08

Maßstab
Pichler
07.08.2019

SCHNEIDER
Torsysteme